

Bass Amplifier Monolithic IC MM1124

Outline

This IC was developed to boost bass on TV and free-standing VCR decks, etc.
The recent trend toward large-screen TV and movie software has increased the demand for powerful bass and wider sound, so that the bass boost function has become part of TV and VCR functions.
This IC was designed especially for bass, and easily reproduces a powerful sound.

Features

1. Dynamic bass boost
Boost can be adjusted higher for lower sound, and smaller for bigger sound.
2. Boost switching pin
Boost amount can be switched for music and video software, giving a change to the set
3. High range boost
By boosting the high range as well, a more realistic sound is reproduced
4. Boost attack circuit
Gives quick response and follows sudden volume changes

Package

SOP-16B (MM1124AF, MM1124BF, MM1124CF)
DIP-16B (MM1124AD, MM1124BD)

Series Table

Model name	Boost		Boost start input level
	FULL	1/2	
MM1124A	19dB	14dB	+3dBm
MM1124B	12dB	8dB	+3dBm
MM1124C	8dB	4dB	-14dBm

Note 1 : Boost amounts for are input level of -37.8dBm

Note 2 : The above are reference values, and may vary depending on the specifications.

Absolute Maximum Ratings (Ta=25°C)

Item	Symbol	Ratings	Units
Storage temperature	T _{STG}	-40~+125	°C
Operating temperature	T _{OPR}	-20~+70	°C
Power supply voltage	V _{CC max.}	-0.3~+15	V
Operating voltage	V _{CC}	+5~+12	V
Allowable loss	P _d	350 (SOP-16B) 1200 (DIP-16B)	mW

Electrical Characteristics (Ta=25°C)

Item	Rank	Measurement conditions			Min.	Typ.	Max.	Units
		SW	f (Hz)	V _{IN} (dBm)				
Consumption current		FULL	1k	-7.8		6.6	9.0	mA
Voltage gain		Through	1k	-7.8	-1	0	+1	dB
Boost 1 (Bst1)	A	FULL	100	-37.8	17	19	21	dB
	B	FULL	100	-37.8	10	12	14	dB
	C	FULL	100	-37.8	6	8	10	dB
Boost 2	A	1/2	100	-37.8	Bst1-6	Bst1-5	Bst1-4	dB
	B	1/2	100	-37.8	Bst1-5	Bst1-4	Bst1-3	dB
	C	1/2	100	-37.8	Bst1-5	Bst1-4	Bst1-3	dB
Total harmonic distortion ratio		FULL	1k	-7.8		0.1	0.3	%
		1/2	1k	-7.8		0.1	0.3	%
		Through	1k	-7.8		0.03	0.1	%
Crosstalk		FULL	1k	-7.8		-50	-44	dB
Maximum output voltage		FULL	THD=10%		1.8	2.4		Vrms
Output noise voltage		FULL	V _{IN} =0V, 30kHzLPF			250	500	μVrms
		Through	Rg=10kΩ			25	50	μVrms
Ripple rejection rate	A	FULL	Superimpose VR=0dB (100Hz, 100mVrms) on Vcc and measure output pin			-32	-26	dB
		Through				-48	-42	dB
	B	FULL				-36	-30	dB
		Through				-48	-42	dB
	C	FULL				-42	-34	dB
		Through				-56	-48	dB
SW pin voltage range		FULL	1k	-7.8	0		0.3	V
		1/2	1k	-7.8	1.2		1.6	V
		Through	1k	-7.8	2.5		9	V

Note : No rank indication means common rank

Block Diagram/ Application Circuits

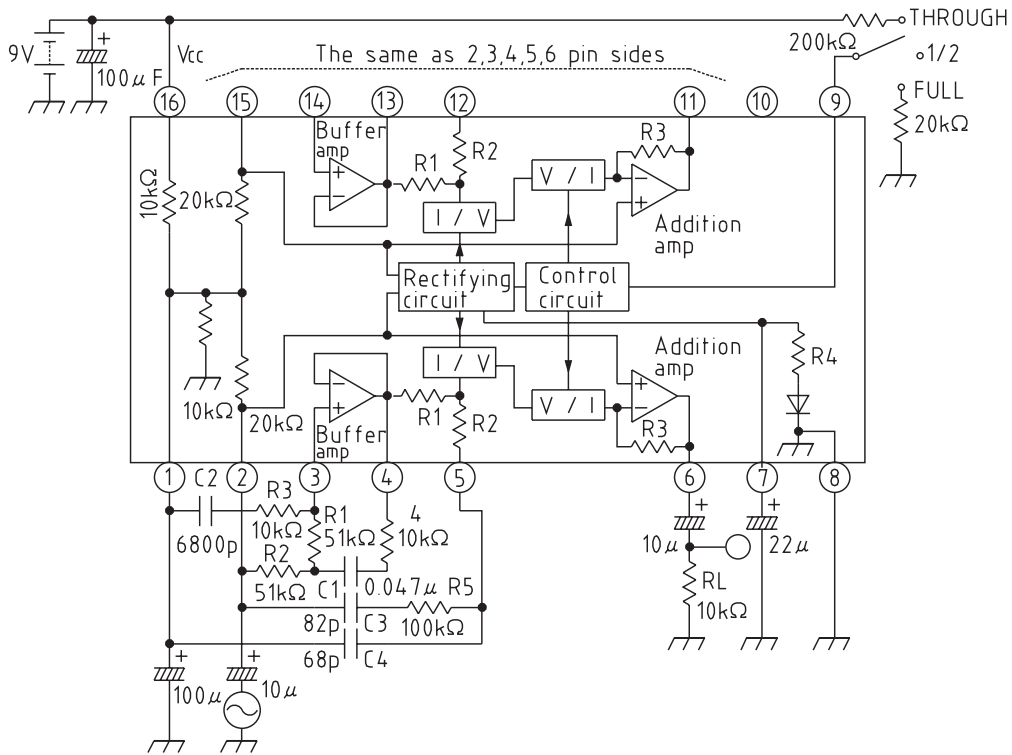

Characteristics

Boost amount-Input level (rank A)

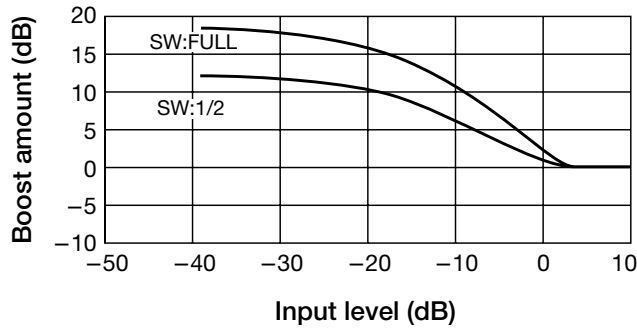

Output level-Frequency (rank A) SW : FULL

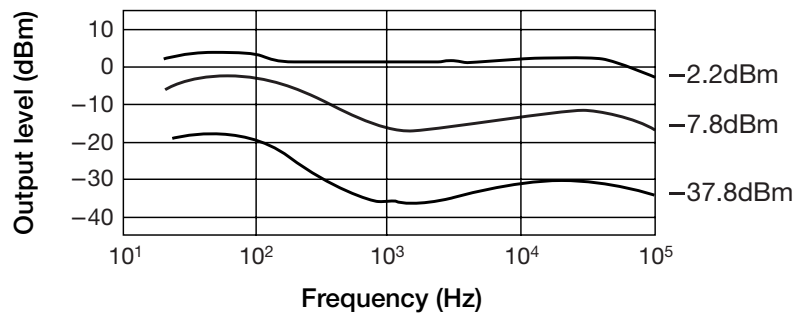

■ Boost amount-Input level (rank B)

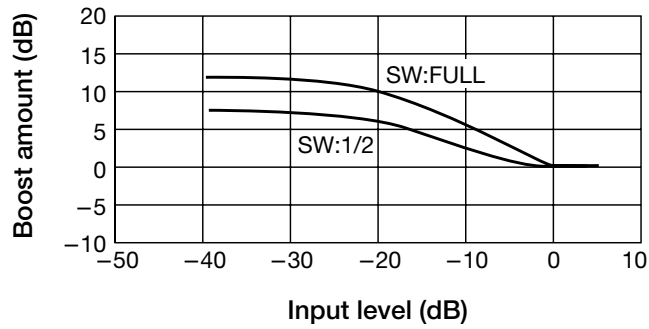

■ Output level-Frequency (rank B) SW : FULL

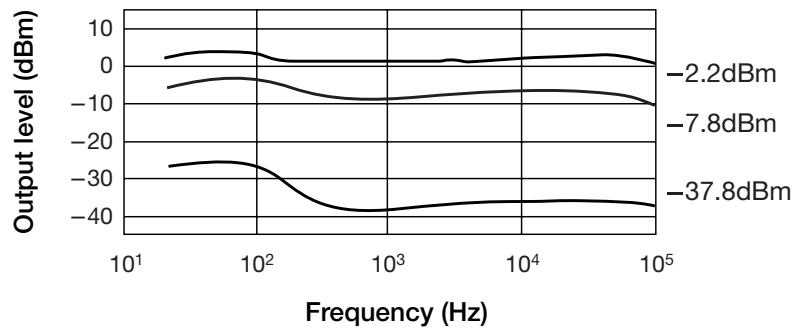

■ Boost amount-Input level (rank C)

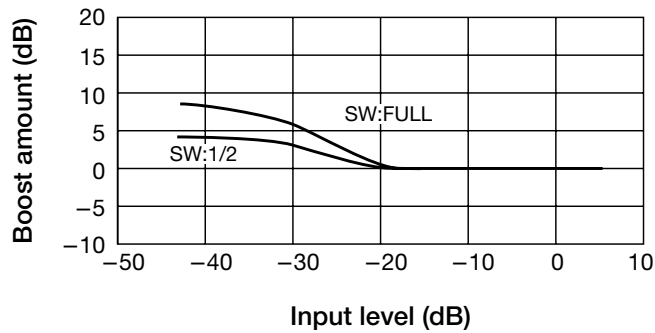

■ Output level-Frequency (rank C) SW : FULL

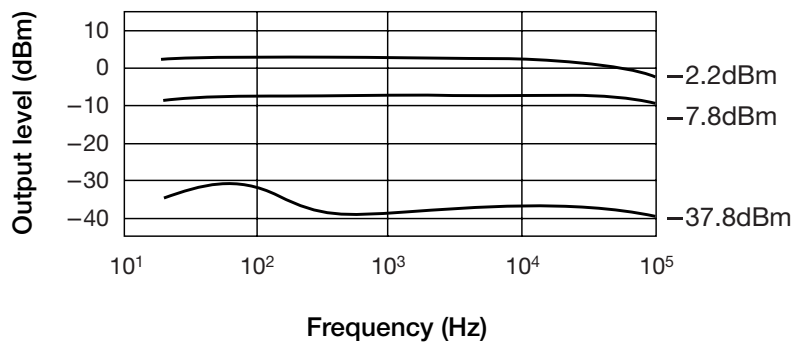

■ THROUGH distortion rate characteristics ($V_{CC}=9V$, $f=1kHz$)

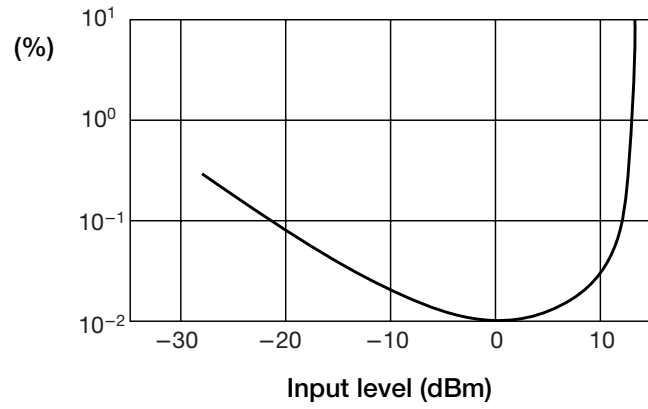

■ CH Crosstalk

